

User Manual

BCL4508E Installation Guide



Shanghai Friendess Co., Ltd

www.friendess.com

Ver 1.0



Content

1. Product Description	3
1.1 Introduction	3
1.2 Hardware resource	3
2. Wiring Instruction.	4
2.1 Installation dimension	4
2.2 Interface specification	5
2.2.1 Interface layout	5
2.2.2 Power supply	5
2.2.3 Servo drive output and parameter setting	6
2.2.4 Limit and origin input	9
2.2.5 DA output	11



1. Product Description

1.1 Introduction

BCL4508E is an extension board based on EtherCAT bus technology, served to provide extra servo control output and DA output for FSCUT2000C, FSCUT3000S, FSCUT4000 system.

1.2 Hardware resource

Hardware table

Item	Qty.	Description
Power supply	/	24V DC/2A
DA	2	0-10V , 12bit , accuracy $\pm 10\text{mV}$
Servo axis	1	One servo control output (open loop)
Pulse direction	1	PUL+/-,DIR+/- differential output, highest output frequency
Encoder	1	A+/A-,B+/B-,Z+/Z-, highest input frequency 223kHz
Work environment		Temperature: 0°C~60°C
		Humidity: 10%~90% (no condensation)
Dimension		133.8×125.6×32.9mm



2. Wiring Instruction

2.1 Installation dimension

The dimension diagram of BCL4508E shown below:

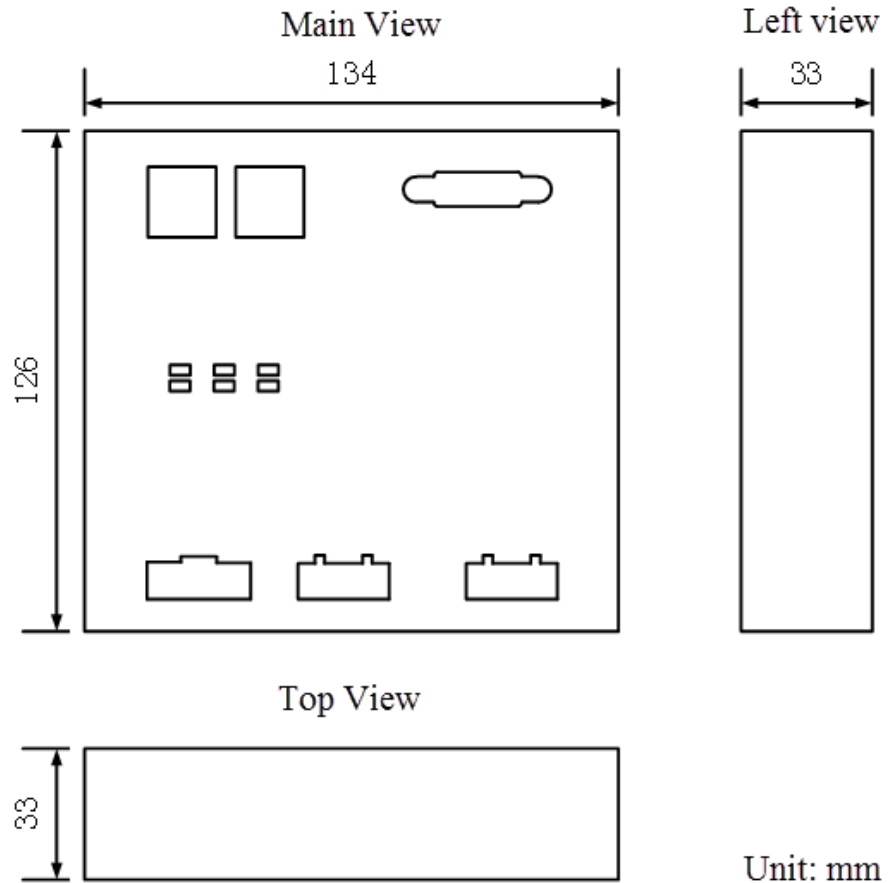



2.2 Interface specification

2.2.1 Interface layout

The wiring terminals of BCL4508E shown below:

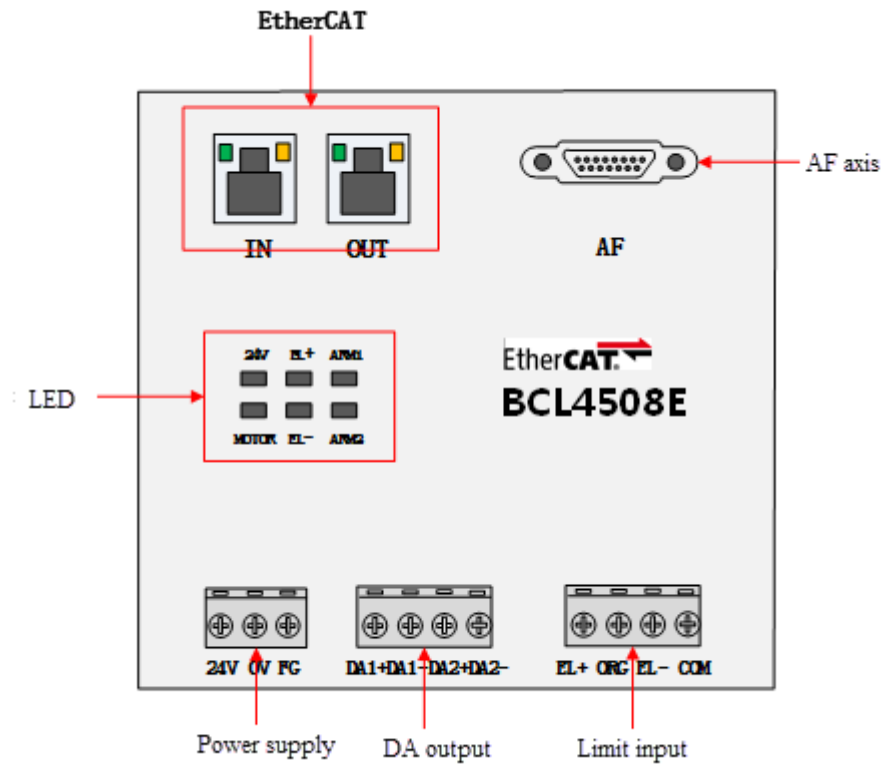

2.2.2 Power supply

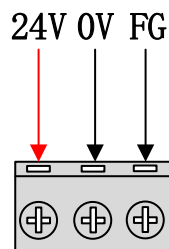

Power supply is 3-pin terminal, the left two ports connect with 24V DC positive and negative input, power cannot be under 48W; The third port must connect to ground by good conductor.



2.2.3 Servo drive output and parameter setting

The servo drive output on BCL4508E is DB15 double-row terminal. The signal pin described below:

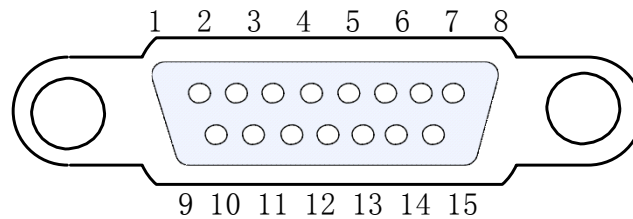

The signal pin of the control cable described below:

15-pin servo drive control cable					
Signal	Color	Description	Signal	Color	Description
1	Purple	PUL+	9	Orange-black	PUL-
2	Yellow	DIR+	10	Red	DIR-
3	Yellow-black	A+	11	Red-black	A-
4	Blue	B+	12	Green	B-
5	Blue-black	Z+	13	Green-black	Z-
6	Black	SON	14	Brown	ALM
7	Black-white	CLR	15	Brown-black	0V
8	Orange	24V			

24V、0V: Provide 24V DC power supply to servo driver;

SON: Enable, servo enable output;

ALM: Alarm, receive alarm signal from servo driver;

PUL+、PUL-: Pulse, differential output;

DIR+、DIR-: Direction, differential output;

A+、A-、B+、B-、Z+、Z-: Encoder 3-phase input.

SON and ALM input only support low-level active.



The wiring diagram with Yaskawa servo driver.

Yaskawa servo wiring diagram

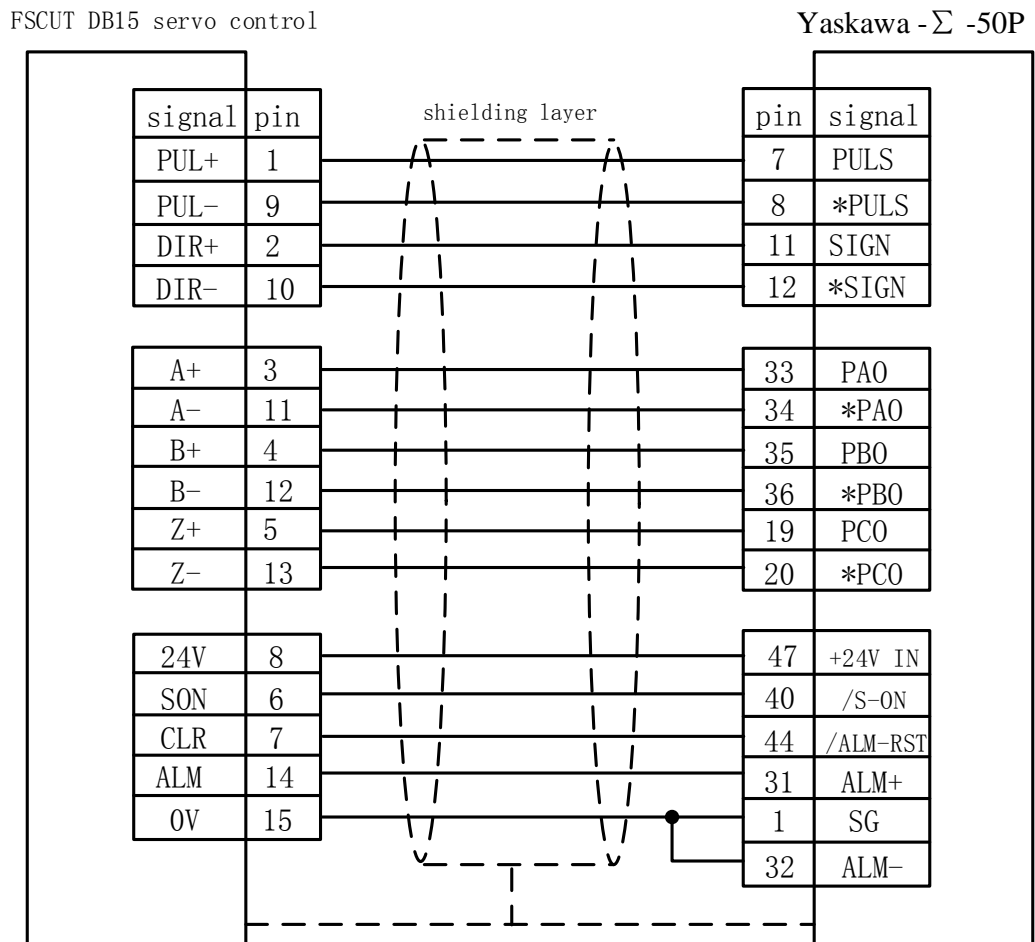

For other brand servo wiring please take notice of following items:

- 1) Check the SON signal of servo driver, make sure it is low-level active type (signal active when conduct with GND end of 24V power supply);
- 2) Check the setting in servo driver, make sure the setting of received signal type is 'pulse + direction';
- 3) Check if there is external emergency stop input at driver side, and confirm the active level of it;
- 4) Provide 24V power supply to I/O board before driver trial run, because 24V power supply servo driver needed given by I/O board;



-
- 5) If driver still can't run, check if the parameter 'positive/negative direction drive inhibit' or similar parameters which restrict motor rotation in driver is disabled.



2.2.4 Limit and origin input

EL-: Negative limit, dedicated input, low-level active;

ORG: Origin, dedicated input, low-level active;

EL+: Positive limit, dedicated input, low-level active;

COM: Ground, common end of above signal pin.

User can set the origin and limit switch as normal-open or normal-close in 'machine config' of FSCUT control software. Select normal-open, input signal pin active when conduct with 0V; Select normal-close, input signal pin active when disconnect with 0V;

The typical wiring diagram of photo-electric switch shown below, must be NPN type 24V switch.

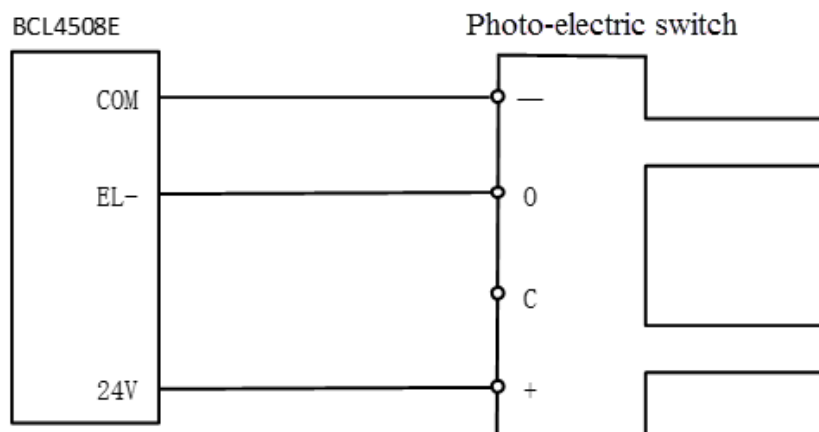



The typical wiring of contact switch shown below.

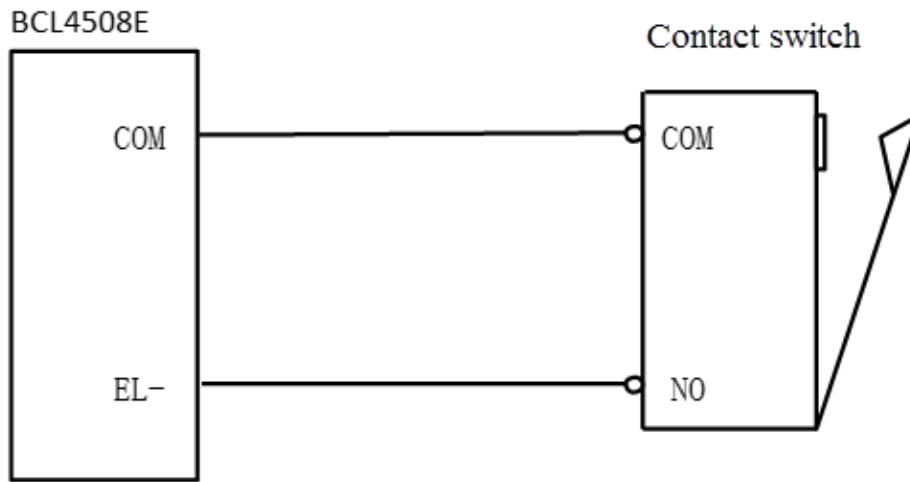



The typical wiring of magnetic switch shown below, must be NPN type 24V switch.

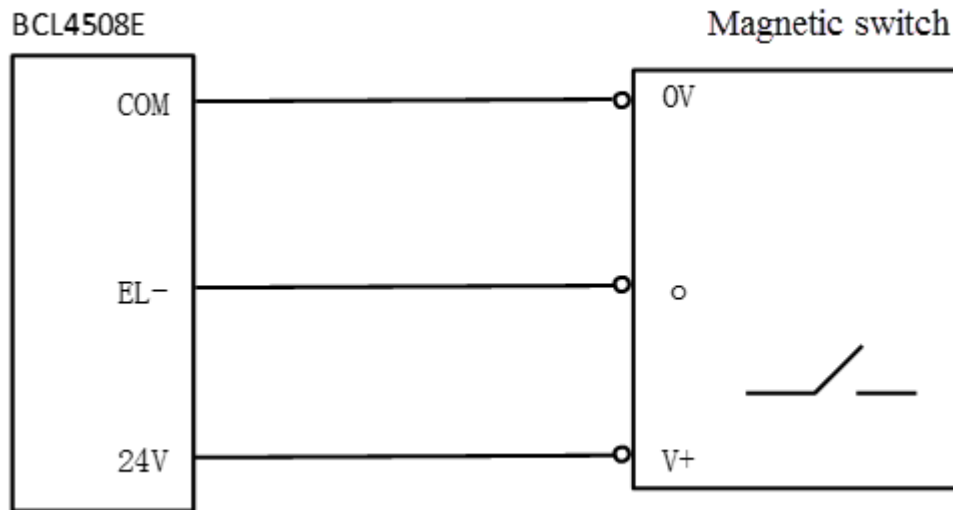

2.2.5 DA output

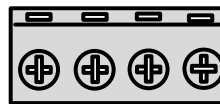

DA1+DA1-DA2+DA2-

BCL4508E has two DA output ports, the first two are DA1+ and DA1-, then DA2+ and DA2-. Two DA channels are same in function, both can output 0-10V voltage, error within $\pm 10\text{mV}$, highest short-circuit current $+25\text{mA}/-30\text{mA}$.